

UNICONT

PMG-400

Universal controller
and display unit

USER'S AND PROGRAMMING MANUAL
1ST edition



Manufacturer:

NIVELCO Process Control Co.

H-1043 Budapest, Dugonics u. 11.

Tel.: 889-0100 ■ Fax: 889-0200

E-mail: sales@nivelco.com ■ www.nivelco.com



TABLE OF CONTENTS

1. GENERAL DESCRIPTION	3
2. ORDER CODE	3
3. TECHNICAL DATA	4
3.1 DIMENSIONS	4
3.2 ACCESSORIES	4
4. MOUNTING	5
5. WIRING	5
5.1 INPUT SELECTION	5
5.2 WIRING POWER SUPPLY, INPUT/ OUTPUT	6
6. CONTROL OUTPUTS	7
6.1 RELAY OUTPUT	7
6.2 SOLID STATE RELAY (SSR) DRIVER OUTPUT	8
6.3 ANALOGUE (4-20 mA) OUTPUT	9
7. SETTINGS, PROGRAMMING	10
7.1 FRONT PANEL, KEYPAD, DISPLAY	10
7.2 BASIC OPERATION	11
7.3 ERROR MESSAGES	11
7.4 SET VALUE (SV)	11
7.5 CONFIGURATION MODE	12
7.5.1 Mode Settings	12
7.5.2 Control Parameters	13
8. CONTROL ALGORITHMS	14
8.1 ON/OFF CONTROL	14
8.2 HEATING/ COOLING (FILLING / EMPTYING) CONTROL	14
8.3 PROPORTIONAL (P) CONTROL	15
8.4 PID CONTROL	15
9. IN- AND OUTPUT MODE SETTINGS	16
9.1 SELECT THE INPUT MODE	16
9.1.1 Analogue input	17
9.2 ALARM RELAY OUTPUT	18
9.3 LOOP BREAK ALARM (LBA)	19
9.4 SENSOR BREAK ALARM (SBA)	20
9.5 AUTOTUNING (AT) OPERATION	20
9.6 DUAL PID CONTROL FUNCTION	21
9.7 RAMP FUNCTION	22
10. SETTING THE CONTROL PARAMETERS	23
10.1 SV-2 FUNCTION (INTERNAL SET VALUE)	23
10.2 IN-B FUNCTION (INPUT CORRECTION)	23
11. FACTORY DEFAULT SETTINGS	24
12. MAINTENANCE, REPAIR	24
13. STORAGE CONDITIONS	24
14. WARRANTY	24

Thank you for choosing a NIVELCO instrument.
We are sure that you will be satisfied throughout its use!

1. GENERAL DESCRIPTION

The **UNICONT PMG-411, PMG-412 and PMG-413** universal analogue PID-controllers can be used for temperature measurement with a Pt-100 resistance thermometer or different thermocouples. The **UNICONT** controllers are also suitable for processing and display the signals of field transmitters with 4-20 mA and 1-5 V DC or 0-10 V DC output. The output signal of the controller can be relay, continuous 4-20 mA process current signal or SSR-driver. The additional alarm relay provides for limit monitoring. The unit is microprocessor based featuring auto-tuning software which is able to find the optimal P-I-D constants automatically. The setting can be performed by the keyboard on the front panel. The large bi-coloured display provides easy reading even from far distance. The process parameters are red, the set values are green.

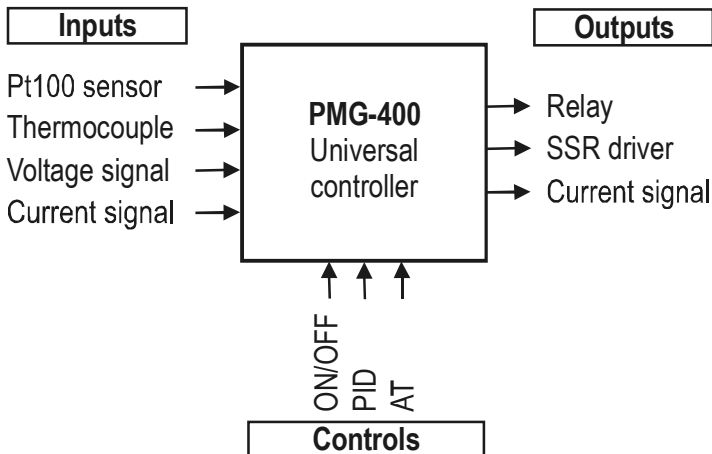

2. ORDER CODE

UNICONT PMG-4 -

INPUT	CODE
1x Universal input	1

OUTPUT	CODE
1x relay + 1x alarm relay	1
SSR driver + 1x alarm relay	2
4-20 mA + 1x alarm relay	3

POWER SUPPLY	CODE
230 V AC	1

3. TECHNICAL DATA

Type		PMG-41□-1		
Input	Resistance thermometer (3-wire, aut. cable compensation)	Pt 100 (-199.9 °C...+199.9 °C or 0 °C...+500 °C) R cable: max. 5 Ω		
	Thermocouple (aut. cold junction compensation)	K (-100 °C ... +1100°C); J (0°C ... +800°C)		
		R (0°C ... +1700°C); E (0°C ... +800°C)		
		T (-200°C ... +400°C); S (0°C ... +1700°C)		
	N (0°C ... +1300°C); W (0°C ... +2300°C)			
	Voltage	1-5 V DC; 0-10 V DC		
	Current	4-20 mA DC		
Control output	PID (auto-tuning)	Proportional band (P)	0 ... 100%	
		Integral time (I)	0 ... 3600 sec	
		Derivative time (D)	0 ... 3600 sec	
		Cycle time (T)	1 ... 120 sec	
	Output	Relay	SPDT; 250 V AC, 3 A, AC1	
		SSR (Solid-State Relay) driver	12 V DC ±3 V (max. 30 mA)	
	Current	4-20 mA DC (max. load: 600 Ω)		
Alarm output		1x SPST programmable relay, 250 V AC, 1 A, AC1		
Setting and display accuracy		±0.3 % ±1 digit for the whole input scale or ±3 °C		
Display	PV (process value)	4 digit, 7 segment 11 mm high red LED		
	SV (set value)	4 digit, 7 segment 7 mm high green LED		
Power supply		100-240 V AC 50/60 Hz, max. 5 VA Allowable voltage range: 90% to 110% of rated voltage		
Electrical connection		Screw type terminals, max. wire cross-section: 0.5 mm ²		
Memory protection		10 years		
Ingress protection		Front side: IP 65, Back side: IP 20		
Electrical protection		Class II. Reinforced Isolation		
Ambient temperature		Operation: -10...+50 °C, Storage: -20...+60 °C		
Ambient humidity		35 ... 85% relative humidity		
Dimensions		48 x 48 x 100 mm (panel cut out: 45.5 ^{+0.6} x 45.5 ^{+0.6} mm)		
Weight		0.15 kg		

3.1 DIMENSIONS

The unit can be mounted into a suitable 1/16DIN (48x48 mm) cut-out place.

Insertion length of the unit is 100 mm, the additional dimensions can be seen on the drawing.

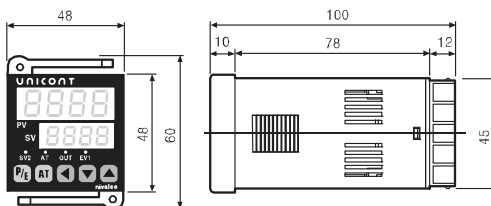

3.2 ACCESSORIES

- User's and Programming manual
- Warranty Card
- Declaration of Conformity
- Mounting bracket

4. MOUNTING

MOUNTING BRACKET

The unit can be mounted with the help of the supplied mounting bracket to the suitable cut-out hole. Be careful with the sealing, which provides proper sealing from the front panel. Suitable distances between multiple units should be taken into consideration.

The cut-out dimensions in case of single, or multiple units should be the following, and width of the mounting-plate is 3–9 mm.

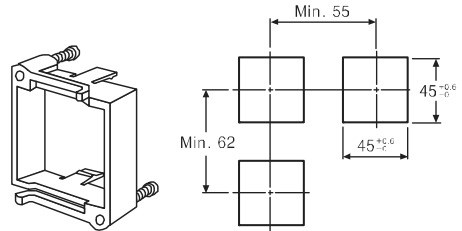

Using the optional **PAM-500-0** front panel adapter the 48x48mm sized unit can be mounted to an existing 96x48mm cut-out hole. In case of using the front panel adapter, the width of the mounting-plate is 3–5 mm.

APPROPRIATE CONDITIONS OF OPERATION

The device is designed for indoor usage only and it should be protected from intense physical damage and direct sunlight. The device cannot be applied in the following places:

- environments which are exposed to strong vibration or other heavy physical impacts
- flammable and dusty environments
- environments above 85% relative humidity and where sudden temperature changes can happen
- strongly acidic or alkaline environments
- environments which are exposed to direct sunlight
- environments which are exposed to strong magnetic fields or strong electrical noise

5. WIRING

5.1 INPUT SELECTION

To select the input mode it is necessary to detach the housing. Before performing the operation always make sure that the device is powered OFF!

Removing the housing should be carried out in two steps shown in the drawing. First press gently the two clips on the back side of the device, and then pull backward the inside part of the device. Select the desired input mode with the help of the S/W1 and the S/W2 pins and the jumpers on the circuit board. After setting the jumpers, replace the housing to the device.

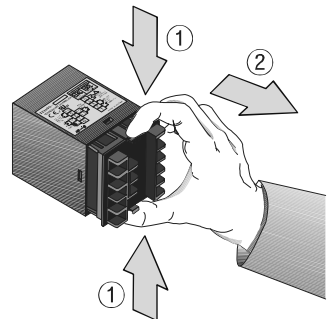

A.) RTD INPUT AND THERMOCOUPLE INPUT	
S/W1	S/W2

B.) VOLTAGE INPUT (1-5 V DC; 0-10 V DC)	
S/W1	S/W2

C.) CURRENT INPUT (4-20 mA)	
S/W1	S/W2

5.2 WIRING POWER SUPPLY, INPUT/ OUTPUT

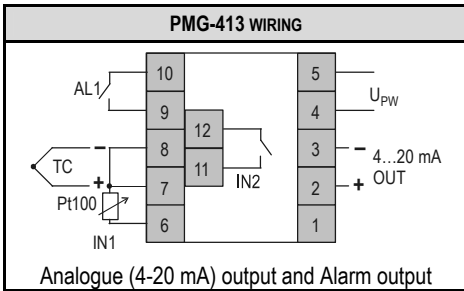
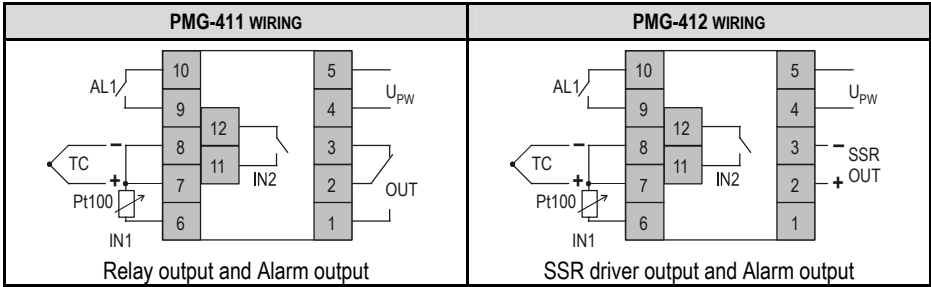

MARKINGS	
U_{PW}	Power supply
OUT	Control output
AL1	Alarm output
IN1	Sensor input
IN2	Control input

Note:

- The power supply should be connected to the terminal via a two-pole isolating switch (preferably located near the equipment) and an anti-surge fuse. The power is recommended to equipped with a suitable sized, U-shaped cable lug:

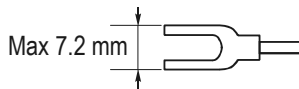

- For wiring the sensors use insulated, shielded cable as short as possible.
- The input signal wires should be separated from the supply wire.

6. CONTROL OUTPUTS

6.1 RELAY OUTPUT

The primary function of the relay output is the realization of the PID control. In case of PID control the relay output discontinuously turns off or on the load, thereby implements the PID control.

If the value of P is 0.0 , ON/OFF control will operate. In case of ON/OFF control the relay output continuously turns off and on the load.

For PID control or ON/OFF control applications it is recommended to use magnet switch or power relay.

- Always make sure to observe the technical specifications for the relay contacts! If the relay is overloaded, it may damage the device.
- When the device is controlling main relay or magnet switch / power relay contact, the flow reverse electromotive force from coil of power relay or magnet switch can cause interference through the supply wire, which may result the malfunction of the device.
- The mechanical lifetime of the output relay is about 10^7 switching which should be taken into account in any case during the design of the control system. If the relay cycle time (t) is set to a short value, the life cycle of the relay is getting lower. It is recommended to choose the type with the SSR driver if the thermal response of the system is fast and therefore the cycle time (t) of the relay should be set to a very low value.

Application example:

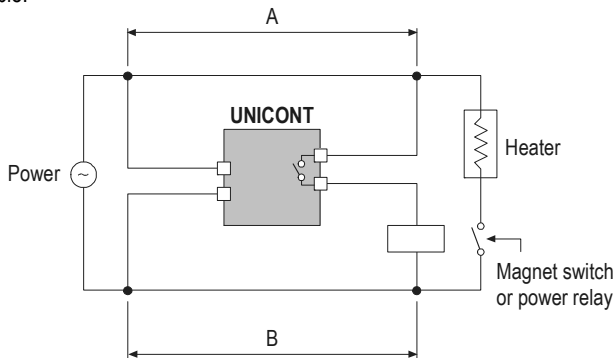

Note:

It is recommended to keep the power relay or magnetic switch as far as possible from the UNICONT controller. If the wire length of 'A' and 'B' is too short the electromotive force occurred from the coil of the power relay or magnetic switch may flow in the power line of the unit which may result malfunction.

6.2 SOLID STATE RELAY (SSR) DRIVER OUTPUT

Using the SSR driver (voltage-impulse) output the unit is suitable for high-speed controlling tasks where the standard relay switching speed is not sufficient.

- SSR driver output is suitable for driving solid state relay with 12 V DC voltage and max.30 mA load.
- For the realization of high-speed control, the cycle time (t_c) of the relay is recommended to set 1 to 2 seconds.

Application example:

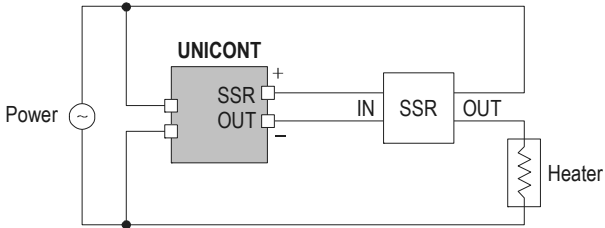

Note:

The solid state relay should be selected according to the capacity of the load otherwise short circuit may occur, which may result fire.

Usage of the SSR driver output is recommended in case of indirect heating in order to provide efficient operation.

6.3 ANALOGUE (4-20 mA) OUTPUT

Using of the analogue output intervening devices with current input can be controlled. As an advantageous feature for example control valve with position control can be controlled using the analogue output. The control output of the unit provides the current value specified by the PID parameters. The 4 mA current value is assigned to 0 % and 20 mA is assigned to 100 %.

- The maximum load of the analogue output is 600 Ω . In case of higher load the current output value will not change proportionally to the measured value.
- When current output is used the Manipulated Value (MV) is changing as analogue form and its value can rarely be 0% or 100%. Therefore **LbA** (loop break alarm) mode can not be used in case of using current output.
- When analogue output is used the OUT (control output) indicator LED on the front panel does not indicate the status of the output.

Application example:

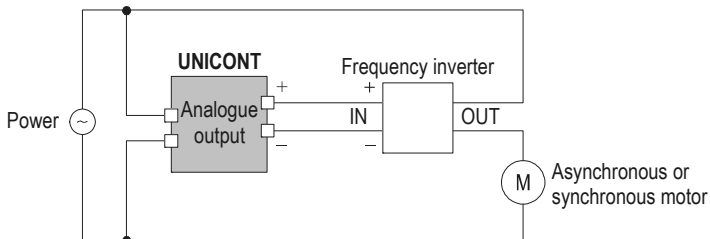

7. SETTINGS, PROGRAMMING

7.1 FRONT PANEL, KEYPAD, DISPLAY

In normal (measurement) mode the 7-segment displays show the measured Process Value and the Set Value. In the other modes it shows texts and values in accordance to the actual state of the programming and configuration.

With the 3 arrow (◀, ▼, ▲) buttons the menu-system can be handled and programming can be performed.

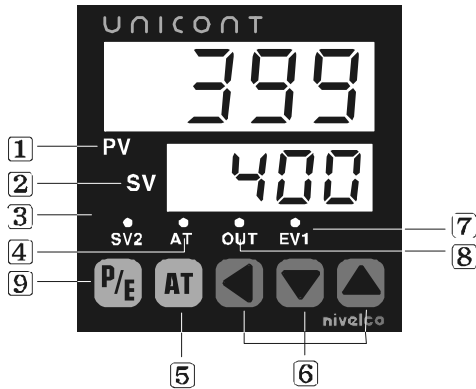

NUMBER	CONTROL PANEL	
	NAME	OPERATION
1	Process Value (PV)	In normal (measurement) mode: display measured Process Value In configuration mode: display selected setting
2	Set Value (SV)	In normal (measurement) mode: display Set Value In configuration mode: display SV or value of selected setting
3	Second SV (SV2) indication	The SV2 (green) LED lights if the internal second SV is active
4	Autotuning (AT) indication	The AT (green) LED flashes to indicate if the device performs the autotuning
5	Autotuning (AT) button	Press the AT button to enter the auto tuning mode
6	◀, ▼, ▲ buttons	Press the ◀ button to move between the digits, with ▼ / ▲ buttons the selected digit value can be changed up or down
7	Event 1 (EV1) output (alarm) indication	The EV1 (red) LED is lit if the alarm output is active
8	Control Output (OUT) indication	The OUT (red) LED is lit if the control output is active
9	P/E button	Press the P/E button to enter the configuration mode or return to the normal (measurement) mode

7.2 BASIC OPERATION

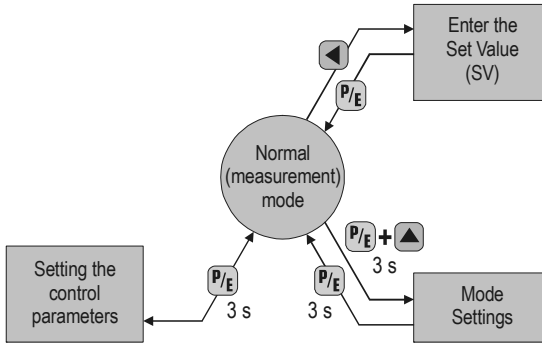

Note:

The controller returns automatically from configuration mode, to normal (measurement) mode if there is no key activity for 60 seconds.

7.3 ERROR MESSAGES

If any error occurs during the operation of the controller the display shows the following error messages:

- "OPEN" flashes on the display if input sensor is not connected or its wire is broken.
- "LLLL" flashes on the display if the measured value is lower than the low limit value in the input range of the sensor (it is likely because the range selection is wrong).
- "HHHH" flashes on the display if the measured value is higher than the high limit value in the input range of the sensor (it is likely because the input selection is wrong).
- "Err0" appears on the display if the device is defective and does not operate.

7.4 SET VALUE (SV)

1.	2.
<p>In normal (measurement) mode, press the ◀ button. The first digit of the set value will be flashing.</p>	<p>Once the desired SV is entered with the arrow buttons (◀, ▼, ▲) press the P/E button to accept the new value. Then the device will return to normal (measurement) mode.</p>

7.5 CONFIGURATION MODE

7.5.1 MODE SETTINGS

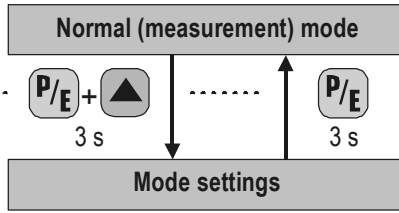

In-t *EU-1* *AL-t* *AL-t* *AL-t* *P Idt* *o-Ft* *Un It* *H-SC* *L-SC* *dot* *rAnP* *LoC* *In-t*

<i>ECRH</i> ↑ ↓	<i>LbA</i> ↑ ↓	<i>AL-A</i> ↑ ↓	<i>tun 1</i> ↑ ↓	<i>Pi dS</i> ↑ ↓	<i>HEAt</i> ↑ ↓	<i>oC</i> ↑ ↓	<i>1300</i>	<i>-100</i>	<i>0</i> ↑ ↓	<i>oFF</i> ↑ ↓	<i>oFF</i> ↑ ↓
<i>ECAL</i> ↑ ↓	<i>SbA</i> ↑ ↓	<i>AL-b</i> ↑ ↓	<i>tun2</i> ↑ ↓	<i>Pi dF</i> ↑ ↓	<i>COOL</i> ↑ ↓	<i>oF</i> ↑ ↓			<i>00</i> ↑ ↓	<i>on</i> ↑ ↓	<i>on</i> ↑ ↓
<i>JICH</i> ↑ ↓	<i>AL-0</i> ↑ ↓	<i>AL-C</i> ↑ ↓							<i>000</i> ↑ ↓		
<i>JICL</i> ↑ ↓	<i>AL-1</i> ↑ ↓	<i>AL-d</i> ↑ ↓							<i>0000</i> ↑ ↓		
<i>r Pr</i> ↑ ↓	<i>AL-2</i> ↑ ↓										
<i>ECrH</i> ↑ ↓	<i>AL-3</i> ↑ ↓										
<i>ECrL</i> ↑ ↓	<i>AL-4</i> ↑ ↓										
<i>ECCH</i> ↑ ↓	<i>AL-5</i> ↑ ↓										
<i>ECCL</i> ↑ ↓	<i>AL-6</i> ↑ ↓										
<i>S Pr</i> ↑ ↓											
<i>In n</i> ↑ ↓											
<i>U It</i> ↑ ↓											
<i>JPEH</i> ↑ ↓											
<i>JPLL</i> ↑ ↓											
<i>dPEH</i> ↑ ↓											
<i>dPLL</i> ↑ ↓											
<i>A--1</i> ↑ ↓											
<i>A--2</i> ↑ ↓											
<i>A--3</i> ↑ ↓											

PROGRAMMING SEQUENCE	
<i>In-t</i>	Select the input from 19 options
<i>EU-1</i>	Select alarm relay mode
<i>AL-t</i>	Select alarm output mode
<i>AL-t</i>	Select auto-tuning mode
<i>P Idt</i>	Select PID control algorithm
<i>o-Ft</i>	Select cooling or heating control
<i>Un It</i>	Select temperature measurement unit
<i>H-SC</i>	Setting the high limit scale value of the analogue input
<i>L-SC</i>	Setting the low limit scale value of the analogue input
<i>dot</i>	Setting the decimal point (only in case of analogue input)
<i>rAnP</i>	Turning on or off the RAMP function
<i>LoC</i>	Turning on or off the Key lock

In normal (measurement) mode press the **P/E** and the **◀** buttons and hold for 3 seconds to change the mode settings. If the configuration is completed press the **P/E** button and hold for 3 seconds to return to normal (measurement) mode.

The *dot* (decimal point setting) menu item appears only if analogue output is used. Also the *A--1*, *A--2*, *A--3* options only appears in the *In-t* (input selection) list if proper jumper settings are made as described in chapter 5.1 „Input“.

7.5.2 CONTROL PARAMETERS

Normal (measurement) mode

P/E

3 s

Setting the control parameters

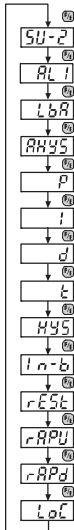

PROGRAMMABLE CONTROL PARAMETERS			
SU-2	Select SV-2 (internal set value) within input range for each sensor. SV-2 is effective if the IN ₂ input is active.		
AL I	Set alarm relay operation value (if alarm relay mode is selected in EU- I).		
LbA (sec)	0	Set the output delay time for loop break alarm (0 ... 999 s) (if LbA is selected in EU- I)	
	999		
AHYS (°C)	1	0.1	Set the value of alarm hysteresis (interval between ON and OFF for alarm output)
	100	100.0	
P (%)	0.0	Set the value of Proportional band in % If value of P is set to 0.0 the unit operates in ON/OFF mode	
	100.0		
I (sec)	0	Set the value of Integral time in seconds If value of I is set to 0 this function will be OFF	
	3600		
d (sec)	0	Set the value of Derivative time in seconds If value of d is set to 0 this function will be OFF	
	3600		
t (sec)	0	Set the value of proportional control cycle time in seconds In case of SSR output this value should be small, for example 2 sec.	
	120		
HYS (°C)	1	0.1	Set the value of switching difference in case of ON/OFF control
	100	100.0	
In-b (°C)	-49	-50.0	Set the correction value for input sensor error Also suitable as an offset function for calibration
	50	50.0	
rEST (%)	0.0	Set the value of manual reset (offset for the Proportional band) in % (for P control only)	
	100.0		
rAPU (min)	1	Set the value of RAMP rising time (in case of heating) Only when rAnP function is on (enabled)	
	99		
rAPd (min)	1	Set the value of RAMP falling time (in case of cooling) Only when rAnP function is on (enabled)	
	99		
LoC	oFF	Turning OFF the key lock	
	oN	When the key lock is active the configuration cannot be changed	
	oN I	When ON1 is selected only the mode settings and auto-tuning is locked	
	oN I		

To change the control parameters, press the **Ⓟ** button and hold for 3 seconds in normal (measurement) mode. If the configuration is completed press the **Ⓟ** button and hold for 3 seconds to return to normal (measurement) mode.

The **AL I, LbA, AHYS, I, d, E, HYS, rAPU, rAPd** parameters will be displayed only if the corresponding options are selected at the operating modes.

8. CONTROL ALGORITHMS

8.1 ON/OFF CONTROL

The ON/OFF control is called two-position control because the output turns ON when the PV falls lower than SV and the output turns OFF when the PV is higher than SV. This control method is not only for controlling temperature it can be also used for basic control method for sequence control or level control.

- The ON/OFF control is operating when the value of Proportional band (**P**) is set to **0.0** at the control parameters.
- If necessary, a programmable temperature difference (**HYS**) between ON and OFF can be set at the control parameters. The setting range is 1 °C to 100 °C (or 0.1 °C and 100.0 °C). If the hysteresis width is too small, too frequent relay switching may occur (contact bounce).
- The **HYS** menu item is available at the control settings only if **P** is set to **0.0** at the control parameters.
- The ON/OFF control mode should not be applied when this type of control method may cause damage to the equipment due to the potentially too frequent ON or OFF cycle (such as cooling compressors).
- Even if ON/OFF control is stable contact bounce can be occurred in the following cases: not sufficient **HYS** value, the capacity of the heating system, the response characteristics of the equipment to be controlled, or mounting position of the sensor. These aspects should be taken into account to minimize to possibility of contact bounce when designing the control system.

8.2 HEATING/ COOLING (FILLING / EMPTYING) CONTROL

The device can control heating or cooling process but also suitable for tank level control tasks. The filling control algorithm is the same as the heating, while the emptying control algorithm is the same as the cooling.

The algorithm can be selected at the mode settings **o-ft** menu.

- **COOL** function: cooling, or emptying control
- **HEAT** function: heating, or filling control

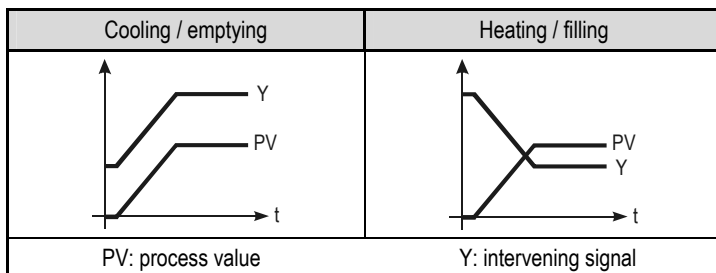

8.3 PROPORTIONAL (P) CONTROL

In case of proportional control the value of the Proportional band (**P**) is not zero but the Integral time (**I**) and the Derivative time (**D**) are set to zero.

- The Proportional band can be set within the range of 1 to 100%.
- The Proportional Control will be accomplished by changing the time of the relay's energised or de-energised state within the cycle time. The cycle time of the relay (**t**) can be set within the range of 1 to 120 s.
- Proportional range: the control range of the cycle time. Out of the proportional range the relay is always energised or de-energised.

The value of the Proportional range: $q = P (\%) * \Delta M$, where ΔM = measurement range.

The position of the Proportional range compared to the Set Value (SV) depends on the percentage value set in the **rESL** control parameter.

- If **rESL** value = 0 %, the whole range is under the SV.
- If **rESL** value = 50.0 %, the proportional range is symmetrical to the SV.
- If **rESL** value = 100 %, the proportional band is over the SV.

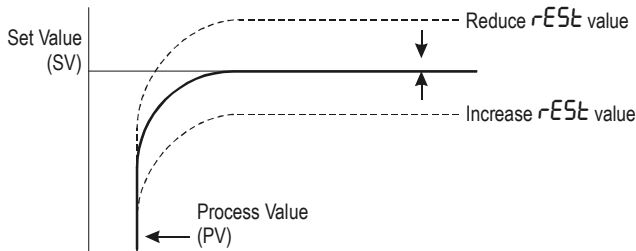

8.4 PID CONTROL

PID control is the most commonly used control mode because the best controlling accuracy can be achieved with it. Similar to the Proportional (P) Control described in the previous chapter, the PID control will be accomplished by changing the relay's energised and de-energised states within its cycle time (**t**). Since the determination of the optimal P-I-D parameters are difficult and time consuming manually the usage of the Autotuning is recommended.

Devices with analogue output (4-20 mA) PID control should be only used. Prior to start the control process it should be determined which control characteristics (cooling or heating) is required.

9. IN- AND OUTPUT MODE SETTINGS

9.1 SELECT THE INPUT MODE

INPUT		DISPLAY	MEASUREMENT RANGE	
K thermocouple	K(CA)H	KCA.H	-100 °C ... +1300 °C	
K thermocouple	K(CA)L	KCA.L	-100 °C ... +999.9 °C	
J thermocouple	J(IC)H	JIC.H	0 °C ... +800 °C	
J thermocouple	J(IC)L	JIC.L	0.0 °C ... +800.0 °C	
R thermocouple	R(PR)	r Pr	0 °C ... +1700 °C	
E thermocouple	E(CR)H	ECr.H	0 °C ... +800 °C	
E thermocouple	E(CR)L	ECr.L	0.0 °C ... +800.0 °C	
T thermocouple	T(CC)H	tCC.H	-200 °C ... +400 °C	
T thermocouple	T(CC)L	tCC.L	-199.9 °C ... +400.0 °C	
S thermocouple	S(PR)	S Pr	0 °C ... +1700 °C	
N thermocouple	N(NN)	n nn	0 °C ... +1300 °C	
W thermocouple	W(TT)	U tt	0 °C ... +2300 °C	
J Pt100	JPtH	JPt.H	0 °C ... +500 °C	
J Pt100	JPtL	JPt.L	-199.9 °C ... +199.9 °C	
DIN Pt100	DPtH	dPt.H	0 °C ... +500 °C	
DIN Pt100	DPtL	dPt.L	-199.9 °C ... +199.9 °C	
0-10 V DC		A--1	-1999 ... +9999	Jumper setting and scaling are needed
1-5 V DC		A--2	-1999 ... +9999	
4-20 mA		A--3	-1999 ... +9999	

9.1.1 ANALOGUE INPUT

When using analogue input the UNICONT controller could be connected to a 4-20 mA output level transmitter device for example.

Scaling:

In case of temperature measurement if the input is Pt100 or thermocouple, the device automatically determines the measurement range and the position of the decimal point according to the selected type of the input signal.

When analogue input is used (4-20 mA, 0-10 V DC, 1-5 V DC) low and high limit values should be specified for the input measurement range. These values can be entered in the **H-SC** and **L-SC** mode settings. In addition you can set the decimal point location at the **dot** mode setting.

Application example:

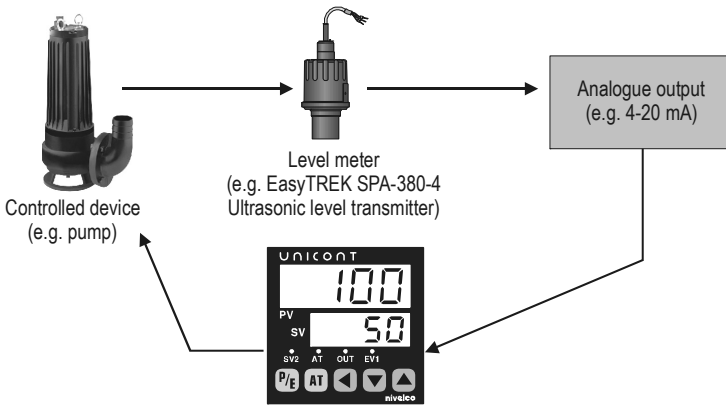

In-t (input mode):	R--3 (4-20 mA)
H-SC (measurement range high level):	6000 (mm)
L-SC (measurement range low level):	0 (mm)
dot (position of the decimal point):	0

Note:

For using analogue input proper jumper settings are required as described in chapter 5.1 „Input“.

9.2 ALARM RELAY OUTPUT

ALARM EVENTS		
LbA		Loop break alarm, see the details: chapter 9.3
SbA		Sensor break alarm, see the details: chapter 9.4
AL-0		No alarm output
AL-1	<p>When AL I is 10 °C</p>	Deviation High limit alarm The output will be ON when the Process Value (PV) is higher than the Set Value (SV) + AL I .
AL-2	<p>When AL I is 10 °C</p>	Deviation Low limit alarm The output will be ON when the Process Value (PV) is lower than the Set Value (SV) - AL I .
AL-3	<p>When AL I is 10 °C</p>	Deviation High/Low limit alarm The output will be ON when the difference between the Process Value (PV) and the Set Value (SV) is higher or lower than AL I .
AL-4	<p>When AL I is 10 °C</p>	Deviation High/Low limit reserve alarm The output will be OFF when the difference between the Process Value (PV) and the Set Value (SV) is higher or lower than AL I .
AL-5	<p>When AL I is 110 °C</p>	Absolute value High limit alarm The output will be ON when the Process Value (PV) is equal to or higher than AL I .
AL-6	<p>When AL I is 90 °C</p>	Absolute value Low limit alarm The output will be ON when the Process Value (PV) is equal to or lower than AL I .

The alarm output (**AL I**) value at the control parameters can be set within the range of 1 °C to 100 °C or 0.1 °C to 100.0 °C. The value of **AL I** determines the position of the energised or de-energised state of the alarm relay.

The 'b' alarm relay switching hysteresis (**AHYS** - time interval between ON and OFF) can be set within the range of 1 °C to 100 °C or 0.1 °C to 100.0 °C at the control parameters.

ALARM RELAY OPTION SETTINGS		
Symbol	Operation	Description
AL-A	General alarm	No optional alarm output, no latching
AL-b	Latch function	Once the alarm output turns ON, it will be continuously activated. It can be turned OFF by selecting AL-A .
AL-C	Standby sequence function	The alarm output will not turn ON the first time when PV reaches SV. The alarm output turns ON only if PV differs from the SV and reaches the alarm value (AL I).
AL-d	Latch & Standby sequence function	Operating latch and standby sequence function together

9.3 LOOP BREAK ALARM (LBA)

The **LbA** (Loop Break Alarm) relay mode allows you to recognize an abnormal temperature of the control system. If the temperature at the control system not changed within ± 2 °C during the specified time set in the **LbA** (loop break alarm delay time) parameter then the output will be ON according to the **AL-t** (alarm relay option) settings.

Example: If the Set Value (SV) is 300 °C and the Process Value (PV) is 50 °C the device controls with 100% gain. If there is no change in the temperature of the control system within the selected time interval the unit recognizes that the heater is cut off and the output will be ON.

- The **LbA** value can be entered at the control parameters.
- The **LbA** value can be set only if the **LbA** mode is selected at the alarm relay output operating modes.
- **LbA** mode can be selected at the mode settings under the **EU- I** menu item.
- The setting range of the Loop Break Alarm is 1 to 999 second.
- If the thermal response of the control system is slow, **LbA** should be set to sufficiently high value.
- The **LbA** mode operates only when the manipulated value of the controller is 0% or 100% therefore **LbA** mode cannot be used with current output.
- If the output is ON in the **LbA** mode, check the following:
 - Short-circuit or wire break at the temperature sensor
 - Improper operation of the controlled equipment
 - Improper operation of the load (heating / cooling device)
 - Wrong wiring
- In case of sensor failure if **LbA** mode is ON the output will not be active. In this case turn OFF the unit, reconnect the sensor and then turn ON.
- When **LbA** mode is used **SbA** and the other alarm operation functions cannot be used.

9.4 SENSOR BREAK ALARM (SBA)

When **SbA** (Sensor Break Alarm) relay mode is used the alarm output indicates when sensor line is cut or open. This can be indicated for example by connecting a buzzer or an emergency light to the alarm output.

- **SbA** mode can be selected at the mode settings under the **EU- I** menu item.
- When **SbA** mode is used **LbA** and other alarm operation functions cannot be used.

9.5 AUTOTUNING (AT) OPERATION

The Autotuning function determines the optimal P-I-D constants and the cycle time based on the automatically measured thermal characteristics and response of the control system.

- The Autotuning function is recommended to use at initial time after connecting the sensor and turning on the device.
- To start the Autotuning press the **AT** button for 3 seconds or more.
- When the Autotuning is started AT (green) LED will blink, after the Autotuning is finished the AT LED turns off.
- While the Autotuning function is executing it can be cancelled by pressing the **AT** button for 5 seconds or more.
- When the power turns off or the Autotuning process is cancelled manually the P-I-D constants and the cycle time will not be saved and the previously set values remain valid.
- The time constant of P-I-D selected by the Autotuning function can be manually changed at the control parameters (**I**).
- The Autotuning operation mode (there are 2 different options) can be selected at the **At .t** menu item. When **tun 1** mode is selected (factory default setting) Autotuning is executed at the entered Set Value (SV), when **tun2** mode is selected Autotuning is executed at the 70% of the entered Set Value (SV).
- It is necessary to execute the Autotuning periodically since the thermal characteristics of the control system can be changed when the controller is used continuously for a long time.

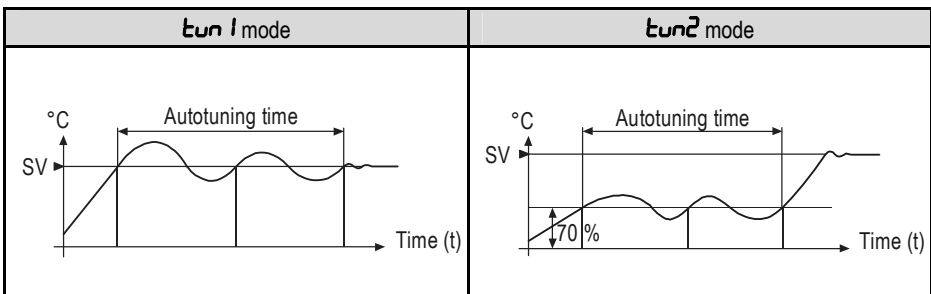

9.6 DUAL PID CONTROL FUNCTION

When controlling temperature there are two different options of PID control characteristics available. The first option is **P Id,F** mode when the controller attempts to minimize the time until the Process Value (PV) reaches the Set Value (SV) and this way small overshoot will occur. The second option is **P Id,S** mode when the controller attempts to minimize overshoot, but this way more time is needed until the Process Value (PV) reaches the Set Value (SV).

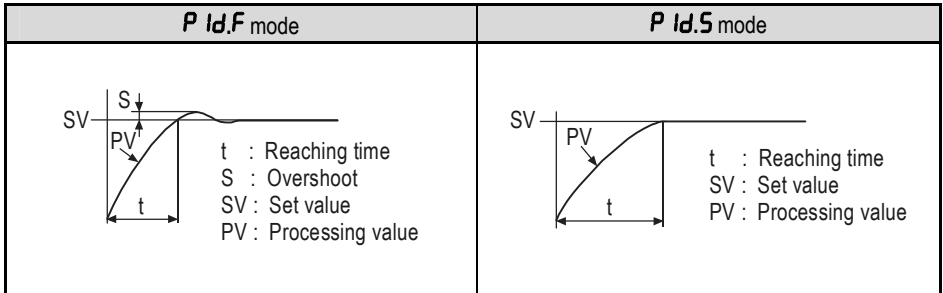

- The PID control mode can be selected at the mode settings **P Id,t** menu. **P Id,F** means the fast and **P Id,S** the slow reaching time option.
- The PIDF operation mode is suitable in applications where controlled equipment requires high speed response such as machines which needs pre-heating, injection molding machines, electric furnace, etc.
- The PIDS operation mode is suitable in applications where controlled equipment is able tolerate only small overshoot, otherwise overheating fire may occur, for example: plating equipment, oil supply system, etc.
- The default value is: **P Id,F**

9.7 RAMP FUNCTION

The RAMP function allows setting delay for the rising or falling time of the temperature. When the Set Value (SV) is changed in case of heating the temperature will change in accordance to the rising time selected in $rAPU$ parameter, in case of cooling the temperature will change in accordance to the falling time selected in $rAPd$ parameter. The rising or falling time can be entered only if $rAMP$ function is enabled (**on**) at the mode settings.

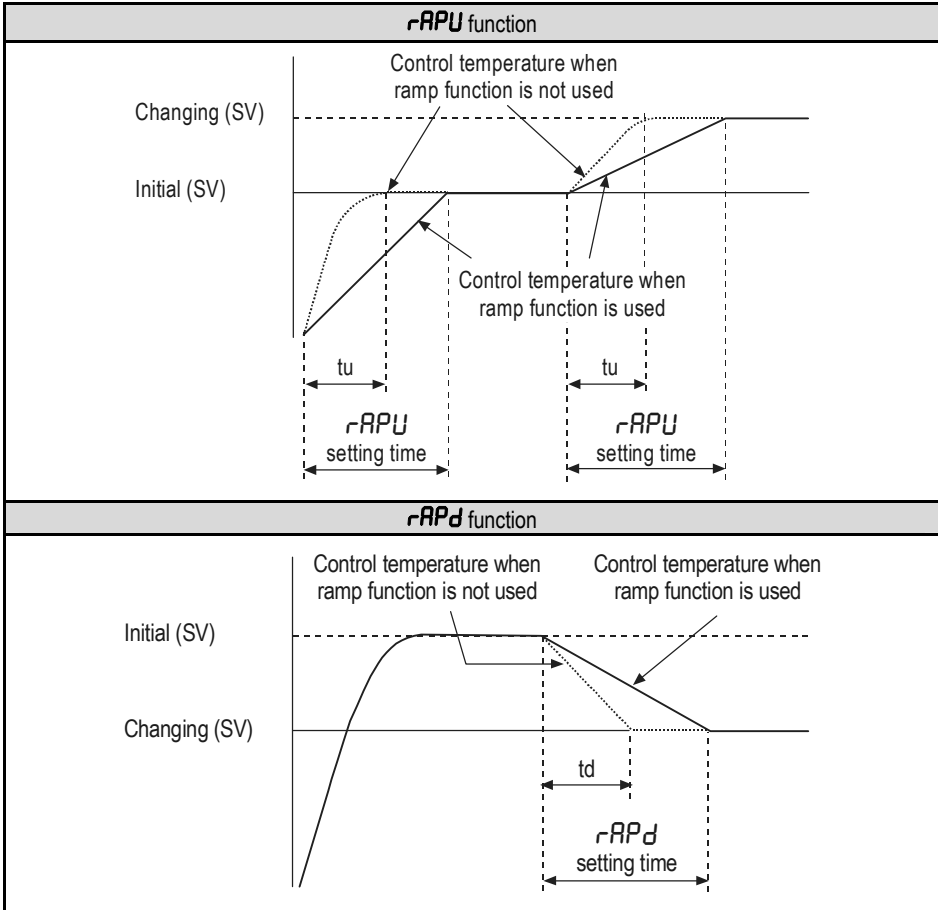

10. SETTING THE CONTROL PARAMETERS

10.1 SV-2 FUNCTION (INTERNAL SET VALUE)

There is a possibility to apply a second (internal) Set Value, using the **SV-2** parameter at the control parameters menu, which will be effective by external relay contact signal connected to the IN₂ control input.

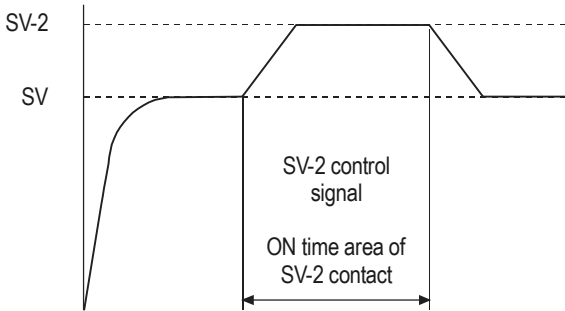

Application example: There is a control system which has to maintain constant temperature such as oven or furnace applications. When the door of the oven is opened the temperature will decrease from the desired value. In this case when the second Set Value (SV-2) is set to a higher value than the Set Value (SV) the temperature will increase fast. If the oven is equipped with a sensor in order to detect the open / closed state of the oven-door the unit will control the temperature efficiently. The switching signal of the sensor should be connected to the IN₂ control input and the second Set Value (SV-2) should be higher than the Set Value (SV).

10.2 IN-B FUNCTION (INPUT CORRECTION)

Displayed value can be corrected with a selected value using the **in-b** (input correction) parameter at the control parameters menu. This can be applied for instance to correct temperature deviation or in case of cable compensation of 2-wire Pt100 sensors.

- The input correction value can be entered at **in-b** in the control parameters.
- Use the input correction after the temperature difference between the measured and real value is measured accurately and then set this value for the correction to display the real temperature value.
- The value of the input correction can be selected within the range of -49 °C to +50 °C or -50 °C to +50 °C.

11. FACTORY DEFAULT SETTINGS

MODE SETTING	DEFAULT VALUE
<i>In-t</i>	<i>2CR.H</i>
<i>EU-1</i>	<i>AL-1</i>
<i>AL-t</i>	<i>AL-A</i>
<i>At.t</i>	<i>tun 1</i>
<i>rAñP</i>	<i>oFF</i>
<i>P Idt</i>	<i>P Id.S</i>
<i>o-Ft</i>	<i>HEAt</i>
<i>Un It</i>	<i>°C</i>
<i>H-SC</i>	<i>1300</i>
<i>L-SC</i>	<i>- 100</i>
<i>LoC</i>	<i>oFF</i>

CONTROL PARAMETER	DEFAULT VALUE
<i>SU-2</i>	<i>0</i>
<i>AL 1</i>	<i>10</i>
<i>LbA</i>	<i>600</i>
<i>AHYS</i>	<i>2</i>
<i>P</i>	<i>3.0</i>
<i>l</i>	<i>0</i>
<i>d</i>	<i>0</i>
<i>t</i>	<i>20</i>
<i>HYS</i>	<i>2</i>
<i>In-b</i>	<i>0</i>
<i>rEst</i>	<i>0.0</i>
<i>rAPU</i>	<i>10</i>
<i>rAPd</i>	<i>10</i>
<i>LoC</i>	<i>oFF</i>

12. MAINTENANCE, REPAIR

The unit does not require regular maintenance. Repairs during or after the warranty period are carried out exclusively at the Manufacturer's.

13. STORAGE CONDITIONS

Ambient temperature: -25 ... +60°C
Relative humidity: max. 98 %

14. WARRANTY

NIVELCO provides warranty of 3 (three) years in compliance with details described in the Warranty Card.

pmg4111a0600p_01
2015. May

NIVELCO reserves the right to change technical data without notice!